

Fig. 6



INSTITUT FÜR MASSIVBAU
UND BAUSTOFFTECHNOLOGIE
UNIVERSITÄT KARLSRUHE (TH)

1990

Nr.	Specimen		Fu [kN]
PB5		unstrengthened control beam	660
PB6		monolithic control beam	1243
PB7		full bond anchors 12 mm	1075
PB8		shotcrete with fibres no anchors	1100
PB9		no bond anchors 12 mm	942
PB10		no bond anchors 20 mm	1204

Fig. 7



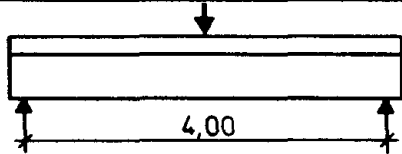
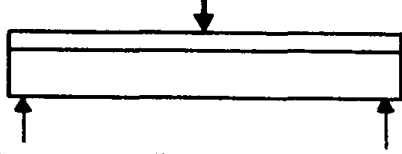
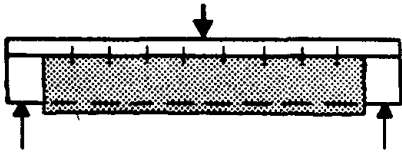
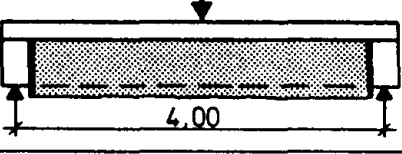
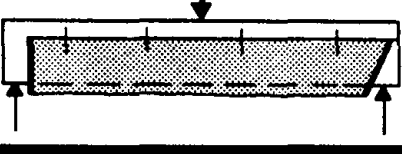
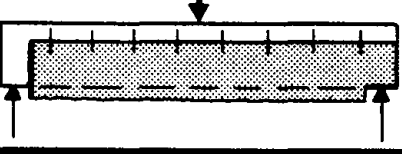
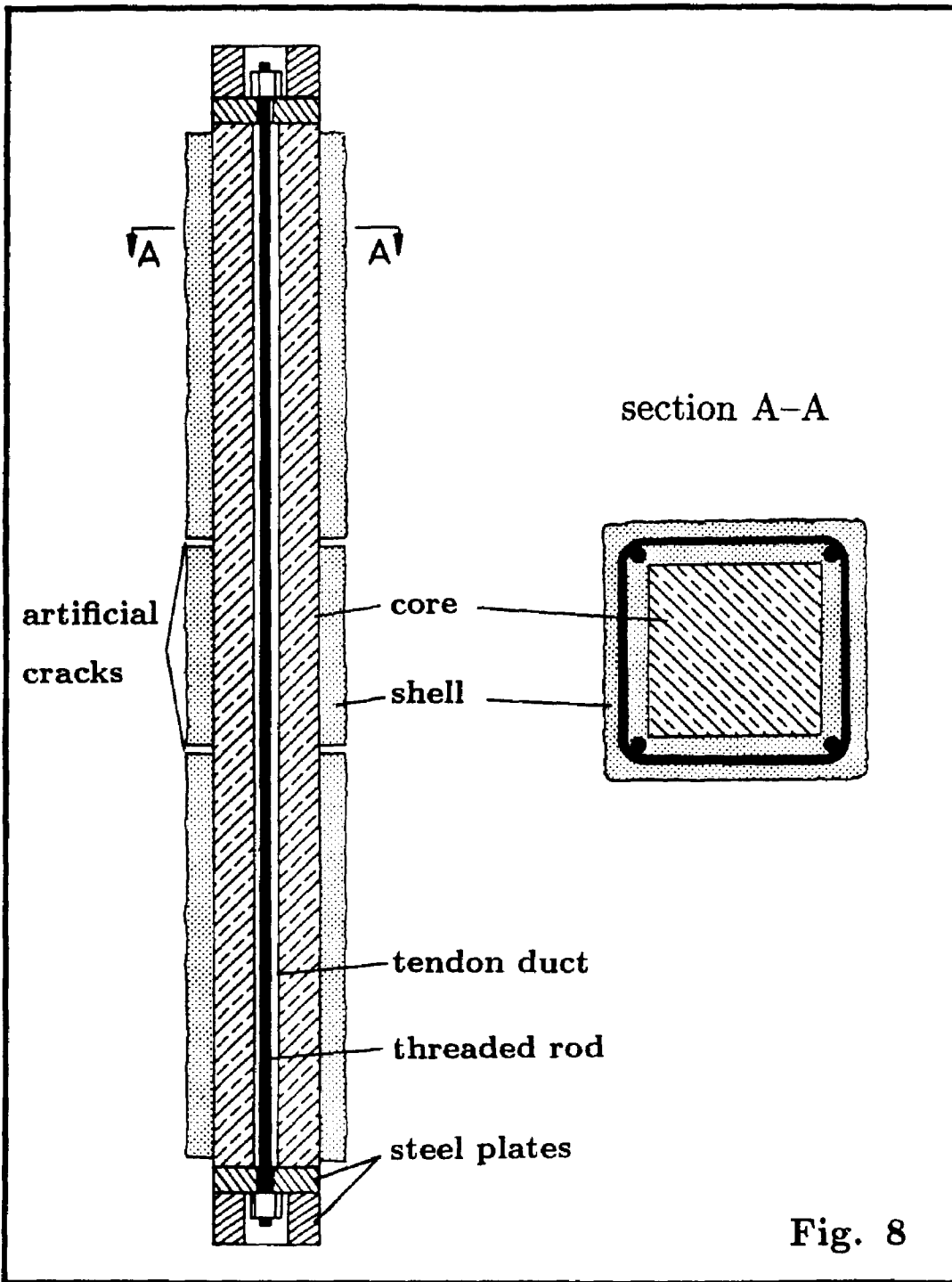

INSTITUT FÜR MASSIVBAU
UND BAUSTOFFTECHNOLOGIE
UNIVERSITÄT KARLSRUHE (TH)

1990

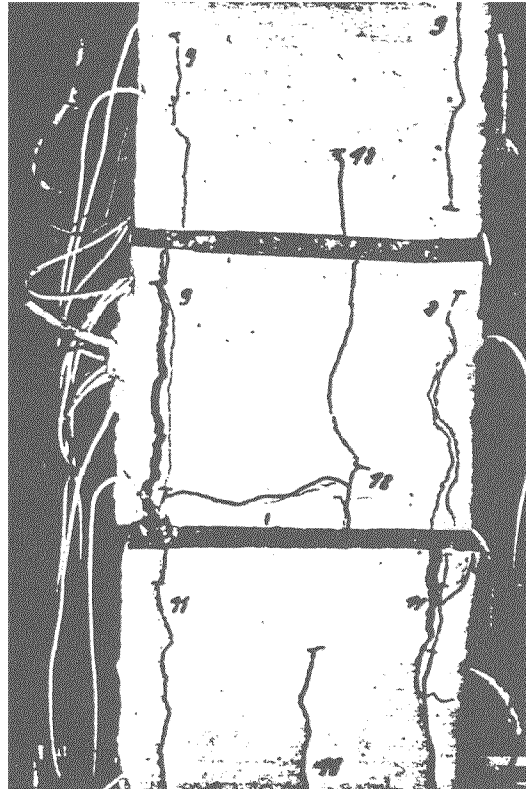

Fig. 9



**INSTITUT FÜR MASSIVBAU
UND BAUSTOFFTECHNOLOGIE
UNIVERSITÄT KARLSRUHE (TH)**

1991

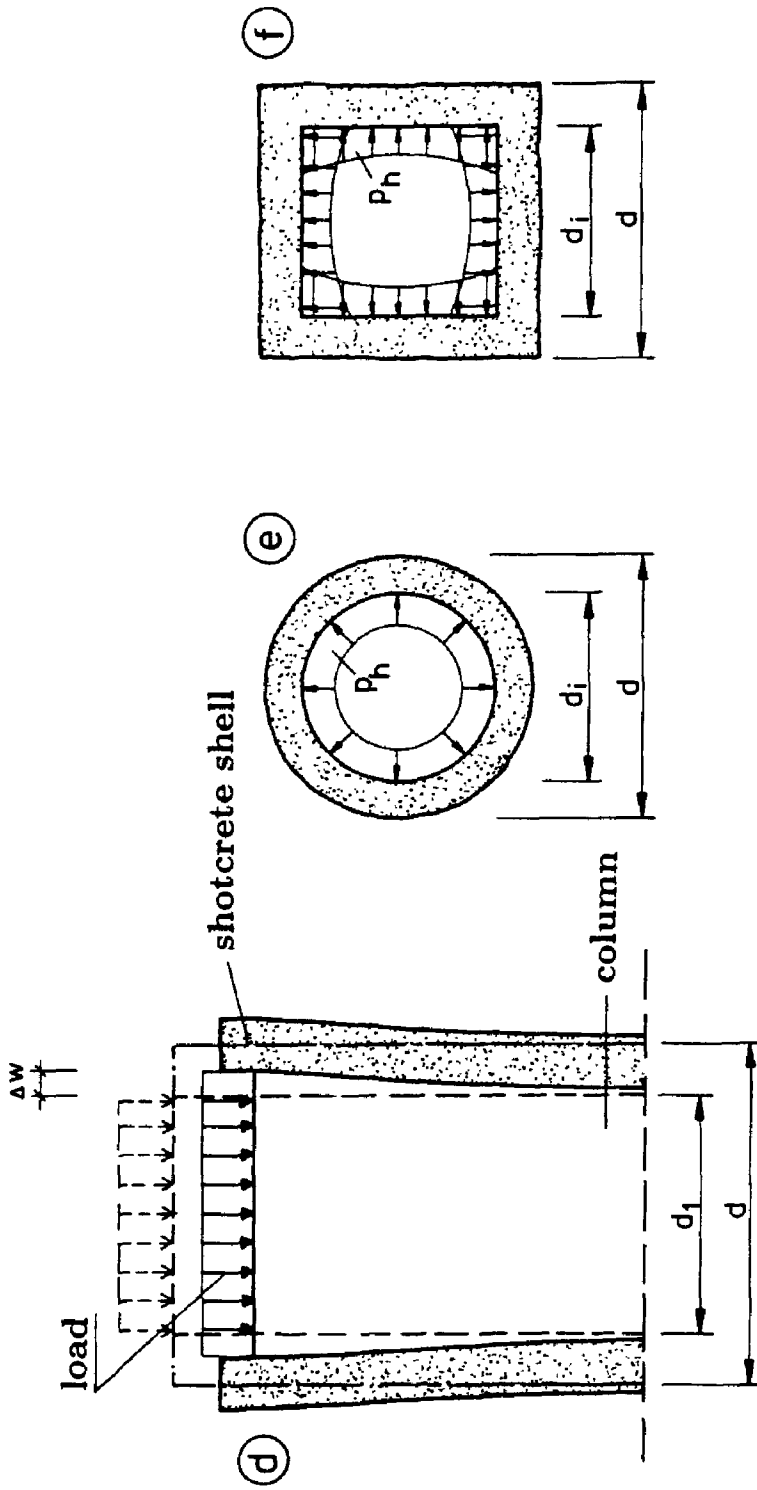

Fig. 10



Fig. 11



**INSTITUT FÜR MASSIVBAU
UND BAUSTOFFTECHNOLOGIE
UNIVERSITÄT KARLSRUHE (TH)**

1991

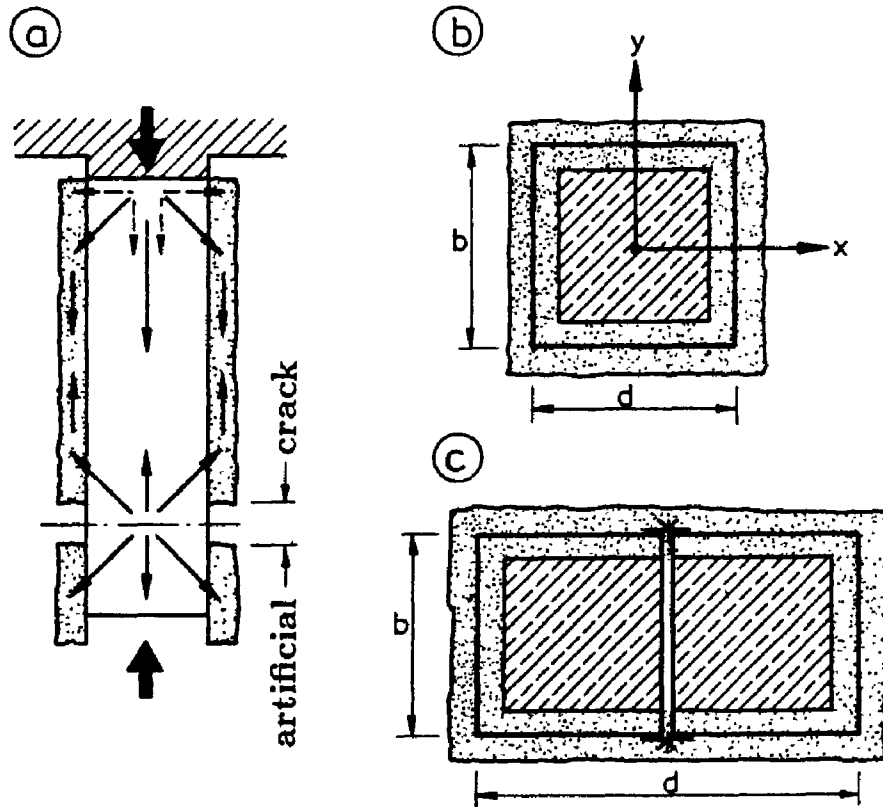

Fig. 12





column	O	B	A	C	D	E	F	G
section								
stirrups in shell	—	—	8/10 8/20	8/7 8/20	10,8/7 8/20	12/7 8/15	12/5,7 10/15	12/5,7 12/15
load appl.								
F _u [kN]	1190 unstrength.	2876 monolith.	2000	2186	2395	2198 cracks	2486 cracks	2394 cracks

Fig. 13

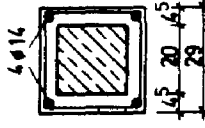
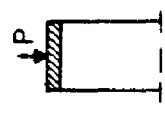
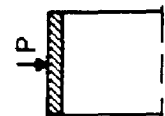
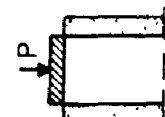
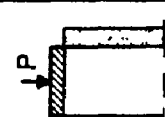
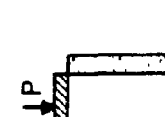
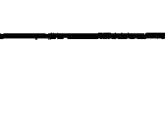